



Fabricante de herrajes  
para puertas de vidrio

# TALLERES PRAGAR, S.L.





C/Lanzarote, 32.- P.I. La Fraila II. - 28970 Humanes (Madrid)







Tel. 91 690 95 85

E-mail: [pedidos@tallerespragar.com](mailto:pedidos@tallerespragar.com)







[www.tallerespragar.com](http://www.tallerespragar.com)

## CERRADURAS CON MUESCA







	<b>501</b>	<ul style="list-style-type: none"><li>- Cerradura central con muesca</li><li>- Con pestillo de cierre interior</li><li>- Acabado brillo</li><li>- Para vidrio 10 mm.</li></ul>
	<b>502</b>	<ul style="list-style-type: none"><li>- Cerradura central con muesca</li><li>- Con pestillo de cierre interior</li><li>- Acabado brillo</li><li>- Para vidrio 10 mm.</li></ul>
	<b>503</b>	<ul style="list-style-type: none"><li>- Cerradura central con muesca</li><li>- Con pestillo de cierre interior</li><li>- Acabado brillo</li><li>- Para vidrio 10 mm.</li></ul>
	<b>603</b>	<ul style="list-style-type: none"><li>- Cerradura vitrina Inox. Con muesca</li><li>- Especial para escaparates.</li><li>- Abierta imposibilidad de sacar llave.</li><li>- Para vidrio 8/10 mm.</li></ul>
	<b>592A</b> <b>592B</b>	<ul style="list-style-type: none"><li>- Cerradura 592A central horizontal</li><li>- Cerradero 592B central horizontal</li><li>- Acabado brillo o satinado</li><li>- Para vidrio 10 mm.</li></ul>





	<p><b>CG</b></p>	<ul style="list-style-type: none"> <li>- Cerradura Inox. central para puerta corredera</li> <li>- Vidrio-Vidrio</li> <li>- Acabado Inox.</li> </ul>
	<p><b>CGP</b></p>	<ul style="list-style-type: none"> <li>- Cerradura Inox. central para puerta corredera</li> <li>- Vidrio-Pared</li> <li>- Acabado Inox.</li> </ul>
	<p><b>040</b></p>	<ul style="list-style-type: none"> <li>- Cerradura central para vidrio 10 mm.</li> <li>- Acabado brillo o satinado</li> <li>- Resbalón y llave con manetas</li> </ul>
	<p><b>P040</b></p>	<ul style="list-style-type: none"> <li>- Cerradura golpe y llave con pomos</li> <li>- Para vidrio de 10 mm.</li> <li>- Acabado brillo o satinado</li> </ul>
	<p><b>040NP</b></p>	<ul style="list-style-type: none"> <li>- Cerradura central para vidrio 10 mm.</li> <li>- Acabado brillo, satinado o dorado</li> <li>- Resbalón y llave, maneta interior y pomo fijo exterior</li> </ul>
	<p><b>P040NP</b></p>	<ul style="list-style-type: none"> <li>- Cerradura golpe y llave pomo interior y fijo exterior</li> <li>- Para vidrio de 10 mm.</li> <li>- Acabado brillo o satinado</li> </ul>
	<p><b>040D</b></p>	<ul style="list-style-type: none"> <li>- Cerradura central para vidrio 10 mm.</li> <li>- Acabado brillo, satinado o dorado</li> <li>- Resbalón y condena interior con manetas</li> </ul>









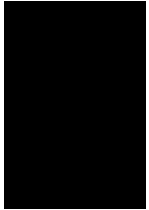
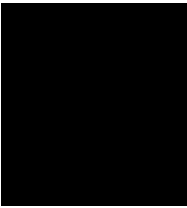

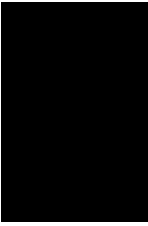
	<p><b>P040D</b></p>	<ul style="list-style-type: none"> <li>- Cerradura resbalón y condena interior con pomos</li> <li>- Para vidrio de 10 mm.</li> <li>- Acabado brillo o satinado</li> </ul>
	<p><b>040NN</b></p>	<ul style="list-style-type: none"> <li>- Cerradura central para vidrio 10 mm.</li> <li>- Acabado brillo, satinado o dorado</li> <li>- Resbalón y llave</li> </ul>
	<p><b>040CP</b></p>	<ul style="list-style-type: none"> <li>- Cerradura central para vidrio 10 mm.</li> <li>- Acabado brillo, satinado o dorado</li> <li>- Solo llave con pomos fijos</li> </ul>
	<p><b>040C</b></p>	<ul style="list-style-type: none"> <li>- Cerradura central para vidrio 10 mm.</li> <li>- Acabado brillo, satinado o dorado</li> <li>- Solo llave</li> </ul>
	<p><b>040N</b></p>	<ul style="list-style-type: none"> <li>- Cerradura central para vidrio 10 mm.</li> <li>- Acabado brillo, satinado o dorado</li> <li>- Resbalón y llave, maneta interior</li> </ul>
	<p><b>P040N</b></p>	<ul style="list-style-type: none"> <li>- Cerradura golpe y llave con pomo interior</li> <li>- Para vidrio de 10 mm.</li> <li>- Acabado brillo o satinado</li> </ul>
	<p><b>040R</b></p>	<ul style="list-style-type: none"> <li>- Cerradura central para vidrio 10 mm.</li> <li>- Acabado brillo, satinado o dorado</li> <li>- Solo resbalón con llave</li> </ul>

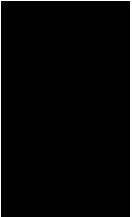
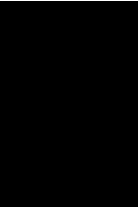
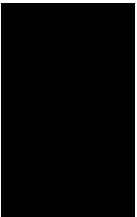

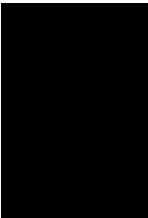

	<p><b>040RR</b></p>	<ul style="list-style-type: none"> <li>- Cerradura central para vidrio 10 mm.</li> <li>- Acabado brillo, satinado o dorado</li> <li>- Solo resbalón con manecilla</li> </ul>
	<p><b>P040RR</b></p>	<ul style="list-style-type: none"> <li>- Cerradura sólo resbalón con pomos</li> <li>- Para vidrio de 10 mm.</li> <li>- Acabado brillo o satinado</li> </ul>
	<p><b>040CD</b></p>	<ul style="list-style-type: none"> <li>- Cerradura con condena interior y desbloqueo exterior</li> <li>- Para vidrio de 10 mm.</li> <li>- Acabado brillo o satinado</li> </ul>
	<p><b>040WC</b></p>	<ul style="list-style-type: none"> <li>- Modelo con indicador libre-ocupado para baños</li> <li>- Para vidrio de 10 mm.</li> <li>- Acabado brillo o satinado</li> </ul>
	<p><b>041E</b></p>	<ul style="list-style-type: none"> <li>- Cerradero central para vidrio 10 mm.</li> <li>- Acabado brillo, satinado o dorado</li> <li>- Llave y apertura eléctrica</li> </ul>
	<p><b>041ET</b></p>	<ul style="list-style-type: none"> <li>- Cerradero central para vidrio 10 mm.</li> <li>- Acabado brillo, satinado o dorado</li> <li>- Llave y apertura eléctrica con tope</li> </ul>
	<p><b>041</b></p>	<ul style="list-style-type: none"> <li>- Cerradero central para vidrio 10 mm.</li> <li>- Acabado brillo, satinado o dorado</li> <li>- Resbalón y llave</li> </ul>

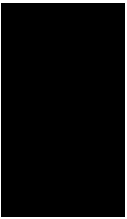
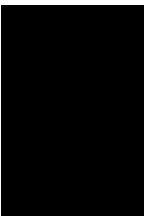

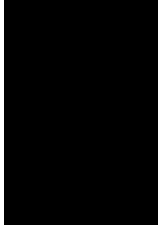
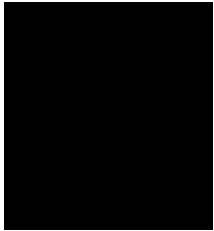

	<p><b>041P</b></p>	<ul style="list-style-type: none"> <li>- Cerradero central para vidrio 10 mm.</li> <li>- Acabado brillo, satinado o dorado</li> <li>- Solo llave</li> </ul>
	<p><b>041PT</b></p>	<ul style="list-style-type: none"> <li>- Cerradero central para vidrio 10 mm.</li> <li>- Acabado brillo, satinado o dorado</li> <li>- Solo llave con tope</li> </ul>
	<p><b>041R</b></p>	<ul style="list-style-type: none"> <li>- Cerradero central para vidrio 10 mm.</li> <li>- Acabado brillo, satinado o dorado</li> <li>- Solo resbalón</li> </ul>
	<p><b>041T</b></p>	<ul style="list-style-type: none"> <li>- Cerradero central para vidrio 10 mm.</li> <li>- Acabado brillo, satinado o dorado</li> <li>- Resbalón y llave con tope</li> </ul>
	<p><b>041RT</b></p>	<ul style="list-style-type: none"> <li>- Cerradero central para vidrio 10 mm.</li> <li>- Acabado brillo, satinado o dorado</li> <li>- Solo resbalón con tope</li> </ul>
	<p><b>091</b></p>	<ul style="list-style-type: none"> <li>- Cerradero central a marco</li> <li>- Acabado brillo, satinado o dorado</li> <li>- Resbalón y llave</li> </ul>
	<p><b>091C</b></p>	<ul style="list-style-type: none"> <li>- Cerradero central a marco</li> <li>- Acabado brillo, satinado o dorado</li> <li>- Solo llave</li> </ul>

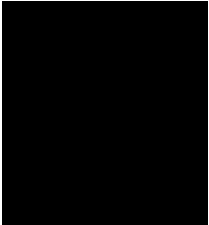
	<p><b>091T</b></p>	<ul style="list-style-type: none"> <li>- Cerradero central a marco</li> <li>- Acabado brillo, satinado o dorado</li> <li>- Resbalón y llave con tope</li> </ul>
	<p><b>091R</b></p>	<ul style="list-style-type: none"> <li>- Cerradero central a marco</li> <li>- Acabado brillo, satinado o dorado</li> <li>- Solo resbalón</li> </ul>
	<p><b>091ET</b></p>	<ul style="list-style-type: none"> <li>- Cerradero central a marco</li> <li>- Acabado brillo, satinado o dorado</li> <li>- Llave y apertura eléctrica con tope</li> </ul>
	<p><b>091ETL</b></p>	<ul style="list-style-type: none"> <li>- Cerradero central a marco</li> <li>- Acabado brillo, satinado o dorado</li> <li>- Llave y apertura eléctrica con tope para grosor 4 mm.</li> </ul>
	<p><b>G0</b></p>	<ul style="list-style-type: none"> <li>- Cerradura golpe y llave con manetas</li> </ul>
	<p><b>GP0</b></p>	<ul style="list-style-type: none"> <li>- Cerradura golpe y llave con pomos</li> </ul>
	<p><b>G0RR</b></p>	<ul style="list-style-type: none"> <li>- Cerradura sólo resbalón con manetas</li> </ul>

	<b>GP0RR</b>	- Cerradura sólo resbalón con pomos
	<b>G0C</b>	- Cerradura sólo llave
	<b>G0NN</b>	- Cerradura golpe y llave
	<b>G0N</b>	- Cerradura golpe y llave maneta interior
	<b>GP0N</b>	- Cerradura golpe y llave pomo interior
	<b>G0NP</b>	- Cerradura golpe y llave maneta interior y pomo fijo exterior
	<b>GP0NP</b>	- Cerradura golpe y llave interior y pomo fijo exterior

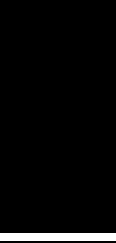
	<b>G0NR</b>	- Cerradura sólo resbalón con llave y maneta interior
	<b>GP0NR</b>	- Cerradura sólo resbalón con llave y pomo interior
	<b>G0CP</b>	- Cerradura sólo llave con pomos fijos
	<b>G0MB</b>	- Cerradura medio bombillo exterior con maneta interior
	<b>GP0MB</b>	- Cerradura medio bombillo exterior con pomo interior
	<b>G0PMB</b>	- Cerradura medio bombillo con pomo fijo exterior y con maneta interior
	<b>G0PPB</b>	- Cerradura medio bombillo con pomo fijo exterior y con pomo interior

	<b>G0D</b>	- Cerradura resbalón y condena interior con manecillas
	<b>GP0D</b>	- Cerradura resbalón y condena interior con pomos
	<b>G0WC</b>	- Modelo con indicador libre-ocupado para baños
	<b>G0CD</b>	- Cerradura con pestillo interior y desbloqueo exterior
	<b>G0BP</b>	- Cerradura medio bombillo exterior con condena interior
	<b>GC1</b>	- Cerradero golpe y llave
	<b>GC1T</b>	- Cerradero golpe y llave con tope

	<b>GC1E</b>	- Cerradero llave y apertura eléctrica
	<b>GC1ET</b>	- Cerradero llave y apertura eléctrica con tope
	<b>GC91</b>	- Cerradero lateral golpe y llave
	<b>GC91T</b>	- Cerradero lateral golpe y llave con tope
	<b>GC91ETL</b>	- Cerradero lateral llave y apertura eléctrica con tope

**SENTIDO DE APERTURA PUERTAS  
SITUACION EXTERIOR**

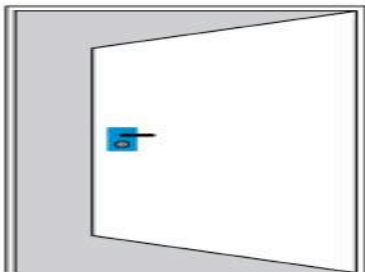

**Interior derecha**  
Interior right inward opening  
Intérieure droite

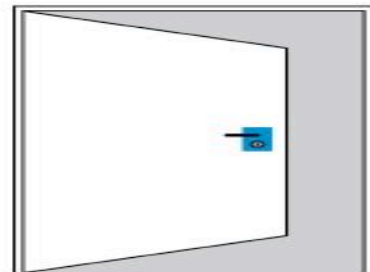

**Interior izquierda**  
Interior left inward opening  
Intérieure gauche

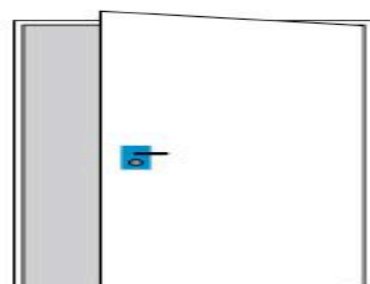
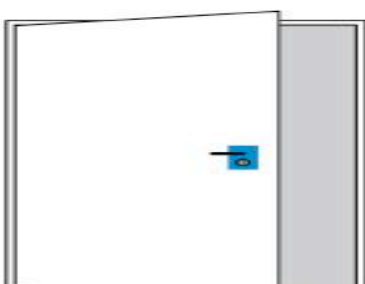



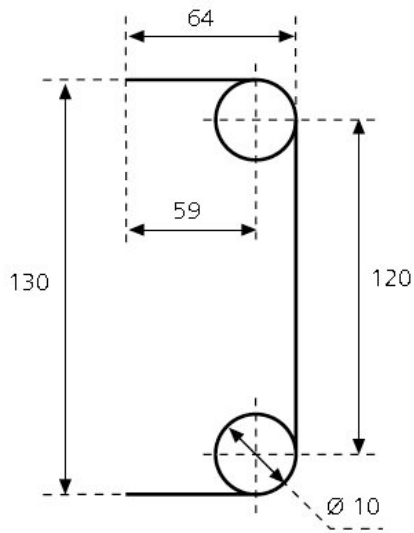



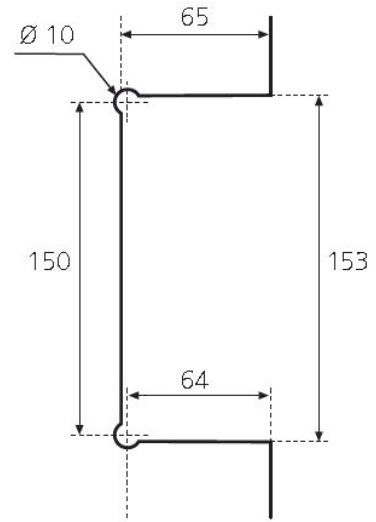



**MUESCA 04**















**MUESCA G**

**CERRADURAS SIN MUESCA**

	<p><b>701</b></p>	<ul style="list-style-type: none"> <li>- Cerradura central con pestillo interior.</li> <li>- Acabado brillo o satinado</li> <li>- Para vidrio 10 mm.</li> <li>- Sin muesca</li> </ul>
	<p><b>504</b></p>	<ul style="list-style-type: none"> <li>- Cerradura central con pestillo interior.</li> <li>- Acabado brillo o satinado</li> <li>- Para vidrio 10 mm.</li> <li>- Sin muesca</li> </ul>
	<p><b>604 Kipón</b></p>	<ul style="list-style-type: none"> <li>- Cerradura kipun 604 Inox. Pivote redondo</li> <li>- Sin muesca</li> </ul>

	<p><b>614-P</b></p>	<ul style="list-style-type: none"> <li>- Cerradero 614 Pivote redondo</li> </ul>
	<p><b>604 Kipón</b></p>	<ul style="list-style-type: none"> <li>- Cerradura kipon 604 Inox. Pivote rectangular</li> <li>- Sin muesca</li> </ul>
	<p><b>614-R</b></p>	<ul style="list-style-type: none"> <li>- Cerradero 614 Pivote rectangular</li> </ul>
	<p><b>Central 596</b></p>	<ul style="list-style-type: none"> <li>- Cerradura central doble hoja rectangular</li> <li>- Sin muesca</li> </ul>
	<p><b>Central Oval</b></p>	<ul style="list-style-type: none"> <li>- Cerradura central doble hoja ovalada</li> <li>- Sin muesca</li> </ul>
	<p><b>570A</b></p>	<ul style="list-style-type: none"> <li>- Cerradura central sin muesca</li> <li>- Para vidrio de 10 a 12 mm.</li> <li>- Acabado brillo o satinado</li> </ul>
	<p><b>570</b></p>	<ul style="list-style-type: none"> <li>- Cerradura central sin muesca</li> <li>- Para vidrio de 10 a 12 mm.</li> <li>- Acabado brillo o satinado</li> </ul>

	<p><b>580A</b></p>	<ul style="list-style-type: none"> <li>- Cerradura central sin muesca</li> <li>- Para vidrio de 10 a 12 mm.</li> <li>- Acabado brillo o satinado</li> </ul>
	<p><b>580</b></p>	<ul style="list-style-type: none"> <li>- Cerradura central sin muesca</li> <li>- Para vidrio de 10 a 12 mm.</li> <li>- Acabado brillo o satinado</li> </ul>
	<p><b>572A</b></p>	<ul style="list-style-type: none"> <li>- Cerradura central sin muesca</li> <li>- Para vidrio de 10 a 12 mm.</li> <li>- Acabado brillo o satinado</li> </ul>
	<p><b>572</b></p>	<ul style="list-style-type: none"> <li>- Cerradura central sin muesca</li> <li>- Para vidrio de 10 a 12 mm.</li> <li>- Acabado brillo o satinado</li> </ul>
	<p><b>582A</b></p>	<ul style="list-style-type: none"> <li>- Cerradura central sin muesca</li> <li>- Para vidrio de 10 a 12 mm.</li> <li>- Acabado brillo o satinado</li> </ul>
	<p><b>582</b></p>	<ul style="list-style-type: none"> <li>- Cerradura central sin muesca</li> <li>- Para vidrio de 10 a 12 mm.</li> <li>- Acabado brillo o satinado</li> </ul>
	<p><b>TD308</b></p>	<ul style="list-style-type: none"> <li>- Cerradura central sin muesca</li> <li>- Para vidrio de 8 a 12 mm.</li> <li>- Acabado satinado</li> </ul>

	<p><b>TD318</b></p>	<ul style="list-style-type: none"> <li>- Cerradura central sin muesca</li> <li>- Para vidrio de 8 a 12 mm.</li> <li>- Acabado satinado</li> </ul>
	<p><b>060</b></p>	<ul style="list-style-type: none"> <li>- Cerradura sin muesca, con condensa y resbalón manecilla móvil interior</li> <li>- Espesor de vidrio 10 mm.</li> </ul>
	<p><b>060B</b></p>	<ul style="list-style-type: none"> <li>- Cerradura sin muesca, con golpe y llave manecilla móvil interior.</li> <li>- Espesor de vidrio 10 mm.</li> </ul>
	<p><b>061ET</b></p>	<ul style="list-style-type: none"> <li>- Cerradero llave y apertura eléctrica con tope.</li> <li>- Espesor de vidrio 10 mm.</li> </ul>
	<p><b>0111ET</b></p>	<ul style="list-style-type: none"> <li>- Cerradero lateral llave y apertura eléctrica con tope.</li> </ul>
	<p><b>0111T</b></p>	<ul style="list-style-type: none"> <li>- Cerradero lateral con tope.</li> </ul>

	<p><b>CBM 2133</b></p>	<ul style="list-style-type: none"> <li>- Cerradura sin muesca para vidrio.</li> <li>- Dimensiones : 50 x 50 mm.</li> <li>- Acabado satinado o brillo.</li> <li>- Para grosor de vidrio 8, 10 o 12 mm.</li> <li>- Posición interior derecha o interior izquierda.</li> <li>- Ideal para puertas correderas.</li> </ul>
	<p><b>CBM 2135</b></p>	<ul style="list-style-type: none"> <li>- Cerradero sin muesca para vidrio.</li> <li>- Acabado satinado o brillo.</li> <li>- Posición interior derecha o interior izquierda.</li> <li>- Ideal para puertas correderas.</li> </ul>
	<p><b>CBM 2149</b></p>	<ul style="list-style-type: none"> <li>- Cerradura sin muesca con llave.</li> <li>- Acabado mate o brillo.</li> <li>- Para vidrio de 10 mm.</li> <li>- Posición : Interior izquierda o interior derecha.</li> </ul>
	<p><b>CBM 2151</b></p>	<ul style="list-style-type: none"> <li>- Cerradero para cerraduras ref. 2149 - 2163 - 2173</li> <li>- Acabado mate o brillo.</li> <li>- Para vidrio de 10 mm.</li> </ul>
	<p><b>CBM 2163</b></p>	<ul style="list-style-type: none"> <li>- Cerradura sin muesca con llave y pomo.</li> <li>- Acabado mate o brillo.</li> <li>- Para vidrio de 10 mm.</li> <li>- Posición : Interior izquierda o interior derecha.</li> </ul>
	<p><b>CBM 2173</b></p>	<ul style="list-style-type: none"> <li>- Cerradura sin muesca sin llave y con resbalon.</li> <li>- Acabado mate o brillo.</li> <li>- Para vidrio de 10 mm.</li> <li>- Posición : Interior izquierda o interior derecha.</li> </ul>
	<p><b>CBM 2175</b></p>	<ul style="list-style-type: none"> <li>- Cerradura con muesca para vidrio.</li> <li>- Con abertura de seguridad y visor exterior.</li> <li>- Dimensiones : 50 x 50 mm.</li> <li>- Posición interior derecha o interior izquierda.</li> </ul>